

## Instruction of Using Our Products

### Cleaning & Maintenance

1. Use general liquid detergent and soft cloth for daily cleaning. Don't use detergent that with acetone or ammonia. Disinfectant with formic acid and formaldehyde is forbidden during disinfection.
2. If there is scratch on the bathtub surface, use 2000# waterproof abrasive paper to polish it and lay toothpaste on. Then use soft cloth to furbish it.
3. Scale deposit can be wiped off with warm citric acid or vinegar by a soft cloth.
4. Screw off the Water Circulation and jets for cleaning when plug up by litter, such as hair
5. Frequent cleaning is not necessary for the parts gilded and silver-gilt
6. Don't clean the tub with hard or coarse material to avoid any scratches; and don't clean the tub by detergent with chemical menstruum to avoid any damages.
7. Be sure to drain off the water and disconnect the power supply after use
8. Don't hit and score the bathtub by hard or keen-edged material. And don't touch the bathtub by cigarette end or heat source that over 70°C
9. Water massage system cleaning: fill the bathtub with 40°C hot water, and add detergent(2g/L). Then run the water massage system for 5 minutes. After that, stop the pump and drain the water. Fill the bathtub with cold water, and run the water massage system for 3 minutes. Clean the bathtub after stopping the pump and draining off the water.

### Precautions

1. The installation should be carried out by a qualified technician, and should be according to the manual.
2. The appliance electric parameter should be tally with the National Safety Standard. And there should be creepage protector on the power supply. Make sure the ground wire is safe. Don't touch the switch, electrical outlet and plug with water.
3. Don't use overheated water. Put cold water first, then hot water. Don't run the appliance until the water level is higher than the jets.
4. The rated voltage of this appliance is 220V. Don't run it when the voltage is over 235V or under 190V.
5. Disconnect the power supply after use
6. Don't take a bath for a long time. Recommended time: less than 30 minutes
7. Please restart the appliance for occasional system halt
8. If the supply cord is damaged, it must be replaced by the manufacturer, its service gent or similarly qualified persons in order to avoid a hazard.
9. This manual is attached with the product. Before installation, please read it carefully. All he installation and use should conform to this manual, to avoid damage or other accident.

### Caution:

1. When the bathtub can't work, please check according to the troubleshooting list. If you can't judge the reason or unable to repair it, please contact us.
2. To insure the customers' safety, the installation should be carried out by a qualified technician. Please use eligible creepage protector. The ground wire should be well connected to the ground.

# harma

## Massage Bathtub Instructions of Installation

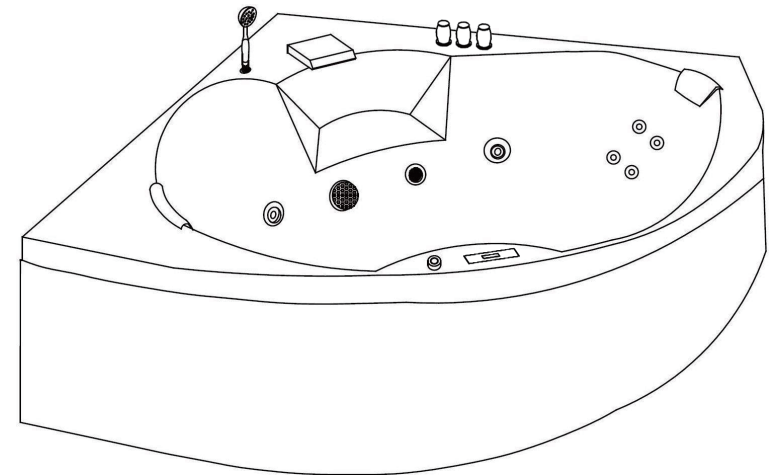

MODEL:MT-NR1500  
SIZE:1500\*1500\*610mm

Dear Customer,  
Thank you for choosing our product. For your safe concern, please take a few minutes to read this manual before installation and use.

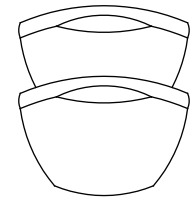
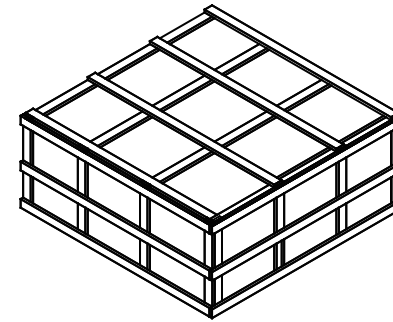

Please use tools to open the packing;  
Make sure all accessories are in the packing

**WARNING**

- 1、 Children and adolescent are only allowed to use the bathtub in accompany with an adult.
- 2、 People with hypertension, diabetes or cardiovascular diseases are not allowed to use the bathtub.
- 3、 Don't hit or rub the bathtub with a hard object to avoid damage and scratches.
- 4、 To avoid stumbling, please pay attention to the drop height when go in or out of the appliance.
- 5、 Watch out the appliance with suds to avoid slip.
- 6、 Don't use acidic and strong alkaline detergent, acetone, ammonia and so on. Clean with alkalescent detergent and soft cloth.
- 7、 If the sealant falls off from the glass, please glue it immediately to avoid the leakage.
- 8、 Specifications can be varied without notice.

**Accessory Box 1 :**

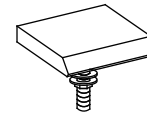

Waterfall faucet 1pc

**Accessory Box 2 :**



Drain 1pc



Drain cover 1pc



Handheld shower hose 1pc

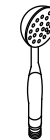

Handheld shower 1pc

**Installation Tools:(no included)**

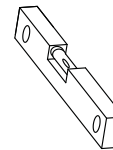

(A)



(B)

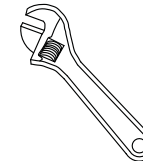

(C)

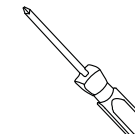

(D)



(E)

A: Gradient B: Sealant C: Adjustable spanner D: Screwdriver E: PTFE tape

Bathtub Configuration

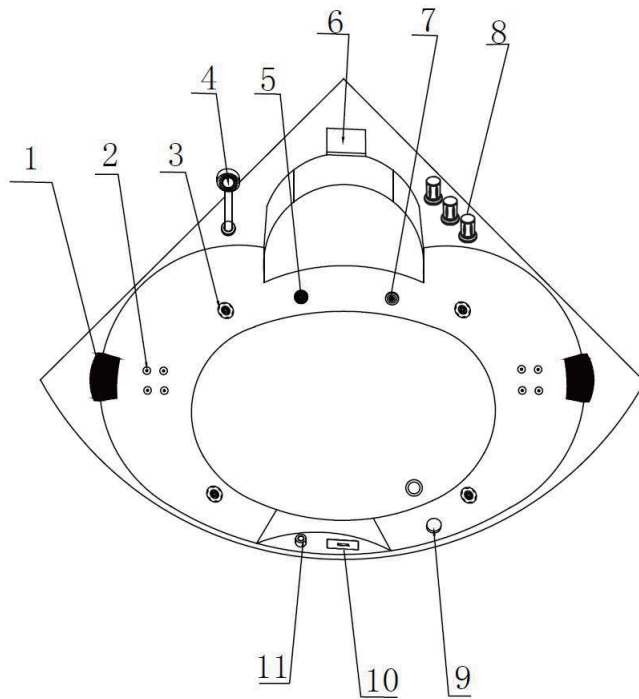

Item	Description	Item	Description
1	Pillow	2	Small jet
3	Big jet	4	Hand shower
5	Underwater light	6	Waterfall
7	Suction	8	Faucet
9	Drainer	10	Regulator
11	Switch		

Installation of Electric Appliance

1. Electric Parameter

Rated Voltage	Rated Frequency	Max Rated Power	Rated Current
220V	50Hz	2260W	10.3A

2. All electrical connections should be made by a licensed, locally certified electrician, in accordance with the requirements of the national electrical codes and procedures.

3. There should be an electric-leakage protector on the power supply. Power lines must be fixed ones, which are with good ground line. The section of the electrical wire should not be less than 2.5 mm<sup>2</sup>. The power supply appliance should be in accordance with the National Safety Standard. And connect the protective ground line on the ground line- mark of bathtub frame (The electric-leakage protector is prepared and connected by user).

4. Warning: when using electrical products, basic precautions should always be followed, including the following.

5. Danger: risk of electric shock! connect only to circuits protected by a Ground Fault Circuit Interrupter (GFCI). A GFCI is not supplied, however, we do specify its use. All known code authorities require a GFCI.

Installation of Water Supply

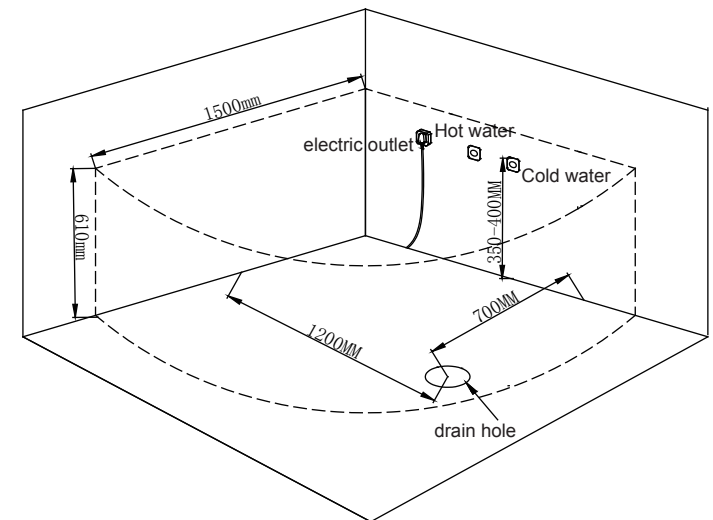

1. Hose Connecting Way

The fittings of bathtub were already connected before shipment except faucet. Users need to install the faucet according to the back procedures, and then connect the cold/hot water hose to the corresponding water supply tube, which should be in the shelter of the bathtub's back.

- A: Water Inlet(Cold/Hot)
- B: Shower and cascade switch
- C: Cascade water inlet
- D: Handheld Shower

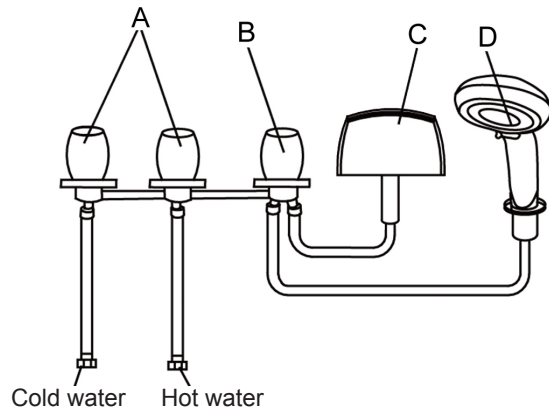

Water Inlet Faucet Connecting

2. Water Supply Chart

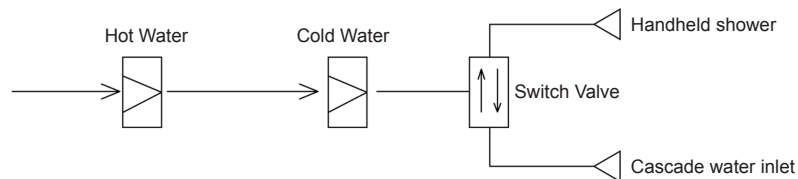

Installation of Bathtub

1. As the picture shows below, turn over the bathtub, wrap the drainer hole with thread PTFE tape, and then screw the drainer.

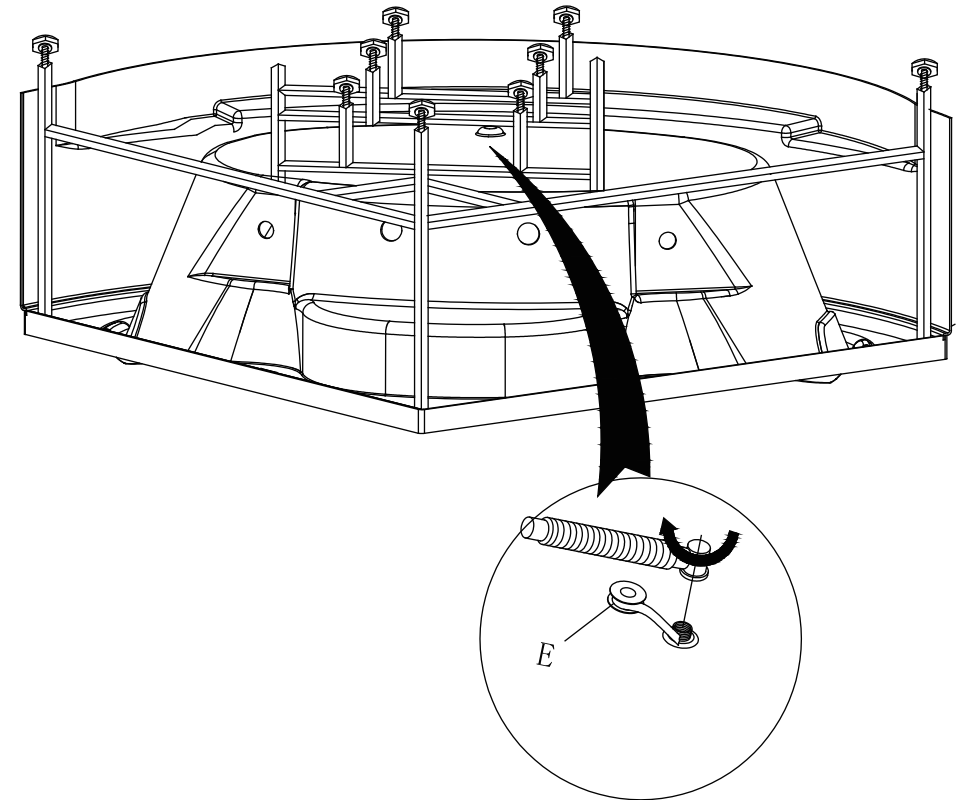

2. As the picture shows below, turn back the bathtub. Install the waterfall, pillow and hand shower, and connect to the water hose. Move the bathtub to the wall corner; put the drainer into sewer and seal the drainer. Adjust the tub feet to make the bathtub horizontal.

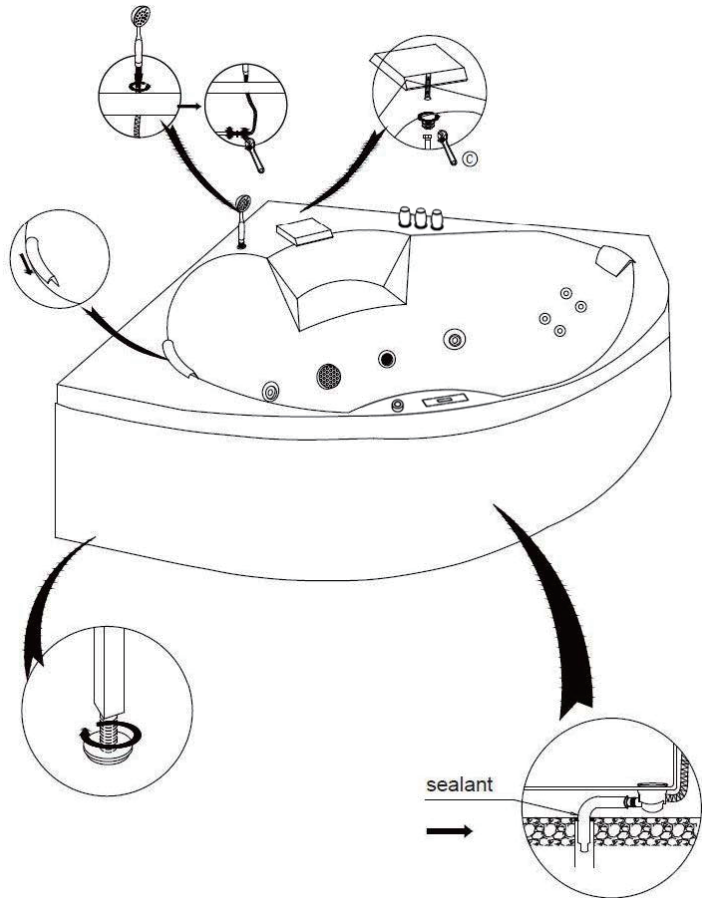

3. Seal the gap between the bathtub and the wall with sealant to avoid water leakage.

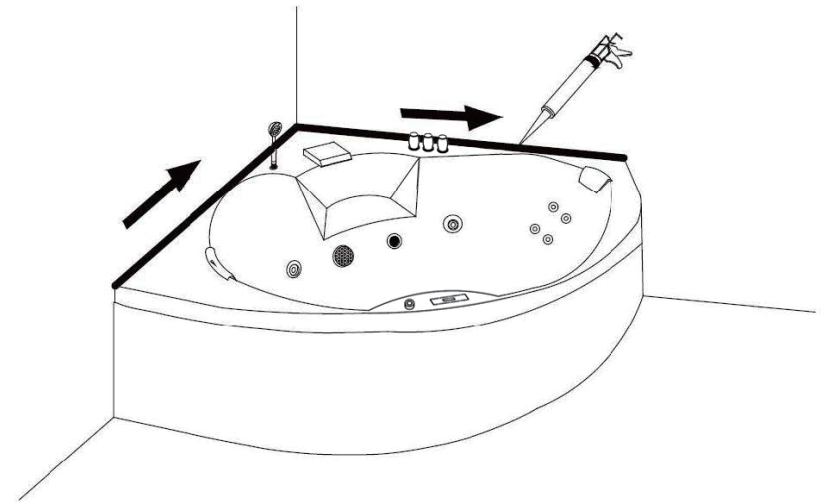

**SCHEMATIC DIAGRAM OF CONTROL PANEL**

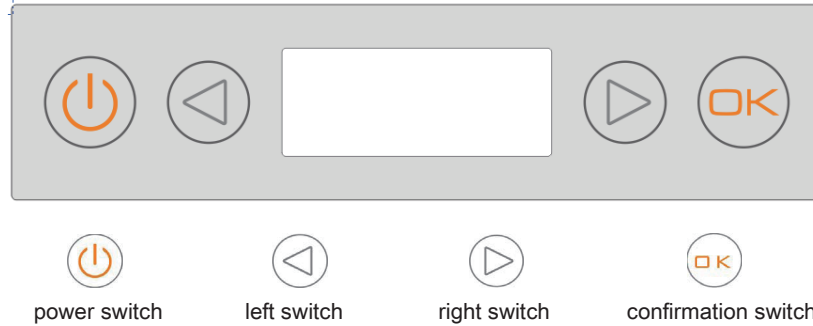

**RUN CONDITION**

1. Water pump surf : AC220V/1.5HP
2. Thermostatic heating : AC220V/1500W
3. Blower : AC220V/300W
4. Bottom lamp : DC12V/1Wx2
5. Ozone : DC12V/6W
6. Loudspeaker : 8Ω/15W

**OPERATION MANUAL**

When any function button works, there is a sound of “ di...”

**1. “  ” POWER**

Press “  ” for 2 seconds to start the controller, at the same time, the lamp is turned on ; press the icon again to stop the controller and all the loads is turned off.

**2. LAMP**





When the system is on, press continuously and “  ” and “  ” till the cursor is on “  ” ; then press “  ” , lamp is turned on ; press “  ” another time , lamp is turned off.

**3. LOCK**





If no operation with the control panel for 3 minutes , all the keys will be locked except “LOCK”, LCD displays “LOCK”.

When the keys were locked , press any key for 3 seconds , the keys will be unlocked after a “di...” , icon “LOCK” disappear.

**4. Ozone (FM radio on , ozone will be turned off automatically)**

- When the system is on, press continuously “  ” 、 “  ” , when the cursor is on “  ” press “  ” ozone will be started. And LCD symbol will be displayed dynamically. Press “  ” again , ozone will be turned off.
- Ozone will be turned off automatically after being started 10 minutes.





**5. Water pump surf**

- The water checking device of this controller protects the water pump from burning out.
- When the system is on, press “  ” “  ” till the cursor moved to “  ” , while the water level achieves the setting value , and then press “  ” to start the pump , the cursor blinks ; press again , Water pump surf is stopped.
- When the water level lowers than the setting value , pump stops working.
- When the water surf pump function is on, and the system checks the water level lower than the setting value , water surf pump function stops automatically , at the same time the pump icon blinks. When any time the system checks the water level achieves the setting value , the icon stops blink and the pump starts to work.





**6. Blue tooth music play (Bluetooth music play cannot be started at the same time with ozone)**



**Password:2288**

6.1 When the system is on, pressing “  ” for 2 Seconds to disconnect the equipment (previously might have been connected with a Bluetooth device during testing phase of the production) and enter blue tooth pairing state. LCD displays “PAIR”.

6.2 when the system is on, press constantly “  ” , “  ” , to move the cursor to “  ” , and then press continuously “  ” , till the LCD displays “BT--C” , then the blue tooth music play function is started ; press again “  ” , till “BT--C” disappears, blue tooth music play is turned off.

6.3 Blue tooth name is “PROW-BT”. If pairing is not done, LCD blinks “BT--C”; if pairing is done, LCD displays “BT--C” statically.

6.4 When the blue tooth function is started, press “  ” , until LCD displays “P--N” , by pressing “  ” to choose next song , by pressing “  ” to choose the last song ; by pressing “  ” for 2 Seconds , to play or pause.

6.5 When the blue tooth music is started, pressing “  ” , until the LCD displays “VOL” , then it enters volume adjusting state. Press “  ” to increase volume , and “  ” to decrease volume. Volume adjusting range is from 0-20, totally 21.

6.6 When the Bluetooth music play function is ozone will be turned off automatically.

7. Thermostatic heating

- This functions works only when the water pump surf function is on.
- Press “◀” “▶” till the cursor moved to “🔥”, and then press “OK” to start the thermostatic heating function.
  - Thermostatic heating function starts or stops according to the water temperature and set temperature (the temperature that the system defaults is 37oC) :  
Controlling rule is as follows:  
If the temperature ≥ setting temperature + 1 ℃, stop heating and LCD heating symbol blinks;  
If the temperature ≤ setting temperature - 1 ℃, start heating and LCD heating symbol displayed in dynamical way.
- Press “OK” again to stop the function.
- Temperature adjustment
  - When the thermostatic heating function is on, press “⏻” till “C” on LCD blinks, then press “▶” or “◀” to adjust the temperature. During the adjusting, LCD displays the setting temperature, then the temperature shall be increased /decreased 1 ℃ after press “◀” “▶” once; When pressing “▶” or “◀” more that 2S, the temperature will increase or decrease by “1 ℃ /0.5s”; stop adjusting for 5 seconds, LCD shall display the current water temperature and system exit temperature adjustment.
- Temperature setting range: 35 ℃ --45 ℃
- If the temperature sensor occurs error, LCD displays “E1” and the controller sounds “di...di...”, in this case the heater cannot be start.

NOTE: The heater only maintains the temperature of the water filled into the bathtub with the range being 35 degrees Celsius to 45 degree Celsius. It does not increase the temperature of the water once filled, but keeps the temperature constant.

Usage

1. Switch on the power supply
2. Turn on the cold/hot water switch, and adjust to the suitable temperature. Use the switch to choose the faucet or handheld shower to let water in.
3. Don't press the water pump switch unless the water level in the bathtub reach to or higher than the jets position.
4. Use air regulator to adjust the massage power.
5. Rotate the handheld shower to adjust the massage effecton.
6. Use light switch to turn on/off the underwater light.
7. Adjust the water divider to use back jets or bottom jets. When the divider handle is in the middle position, you can use both back jets and bottom jets at the same time.
8. Press pneumatic switch, turn off the pumps, and drain the water after use. Then turn off the power supply.

Troubleshooting

Trouble	Possible Reason	Try this to solve
Water pump Don't work.	Power supply is not well connected, the leakage protector disconnect .	Turn on the power supply, and connect the leakage protector .
	Water pump impeller was stuck by sundries.	Clean the water pump impeller.
	The water pump switch is off.	Press the water pump switch.
	Power supply plug don't insert or no enough power supply.	Plug the power supply in.
	Water pump trouble.	Repair or replace the water pump.
Air pump don't work.	No enough power supply.	Check the circuitry and plug the power supply in.
	Switch is off.	Press the air pump switch.
	Power supply plug don't insert.	Plug the power supply in.
Massage power can't be adjusted.	Voltage problem.	Check voltage.
	Adjust switch is off or has problem.	Check, replace the switch.
	Water Circulation is blocked.	Clean the water circulation.
Bathtub don't stand horizontally.	Adjustable foot is not well-adjusted.	Adjust the Adjustable foot.
Water leakage.	Obturatoring ring is not good.	Replace the obturatoring ring.
	Nut is loose.	Screw down the nut.
	Connect part is not well connected.	Pay attention to the connect part conglutination